

REV.	ECN.NO.	MODIFY.CONTENT	DATE
A		NEW	2021/11/06

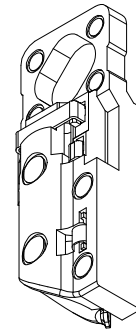

3D VIEW

NOTE:

1. CONTACT CURRENT RATING: 1A.
2. CONTACT RESISTANCE: 100 mΩ MAX.;
3. INSULATION RESISTANCE: 1000Ω MIN.;
4. DIELECTRIC WITHSTANDING: 500V AC MIN.;
5. DURABILITY: 5,000 CYCLES MIN.;
6. CONNECTOR MATING FORCES: 30N MAX.;
7. CONNECTOR UNMATING FORCES: 3N MIN.;

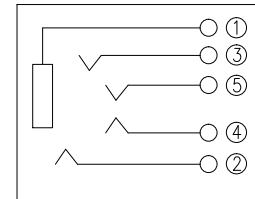
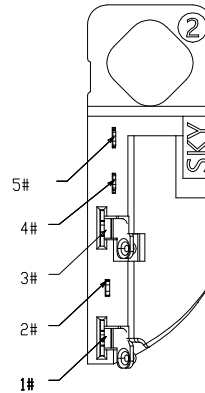
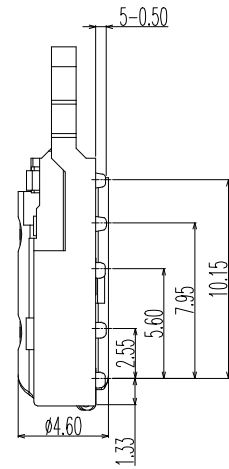
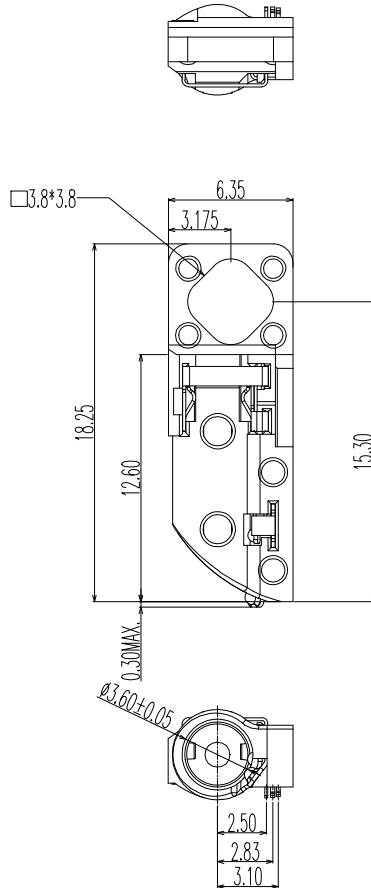

SCHEMATIC

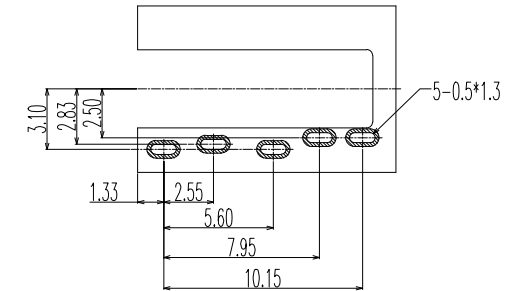

P.C.B LAYOUT (All SIZES±0.05mm)
TOP VIEW

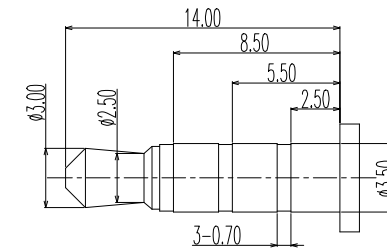

(∅3.50mm 4 POLE PLUG DETAIL DRAWING)

ITEM	NAME	Q'TY	DESCRIPTION	NOTE
6	TERMINAL 5#	1	STAINLESS STEEL; THE BOTTOM OF THE NICKEL(40u" MIN.); GOLD (1u"MIN.) PLATING ON SOLDER AREA ;GOLD (1u"MIN.) PLATING ON CONTACT AREA	T=0.15mm
5	TERMINAL 4#	1	STAINLESS STEEL; THE BOTTOM OF THE NICKEL(40u" MIN.); GOLD (1u"MIN.) PLATING ON SOLDER AREA ;GOLD (1u"MIN.) PLATING ON CONTACT AREA	T=0.15mm
4	TERMINAL 3#	1	PHOSPHOR BRONZE; THE BOTTOM OF THE NICKEL(40u" MIN.); GOLD (1u"MIN.) PLATING ON SOLDER AREA ;GOLD (1u"MIN.) PLATING ON CONTACT AREA	T=0.2mm
3	TERMINAL 2#	1	PHOSPHOR BRONZE; THE BOTTOM OF THE NICKEL(40u" MIN.); GOLD (1u"MIN.) PLATING ON SOLDER AREA ;GOLD (1u"MIN.) PLATING ON CONTACT AREA	T=0.2mm
2	TERMINAL 1#	1	PHOSPHOR BRONZE; THE BOTTOM OF THE NICKEL(40u" MIN.); GOLD (1u"MIN.) PLATING ON SOLDER AREA ;GOLD (1u"MIN.) PLATING ON CONTACT AREA	T=0.2mm
1	HOUSING	1	PPA COLOR BLACK	

GENERAL TOLERANCE		DWG NO.		APPD:	WIND	Scale	1:1
X.±0.45	x.*±5°	Title	∅3.5mm PHONE JACK ∅4.4 mm LOCK BOARD TYPE CONNECTOR	CHKD:		UNIT	mm
.X±0.35	.x.*±2°			DR:			
.XX±0.25	.xx.*±1°	Part NO.	JYS-JK460-066	Date	2021/11/06		
.XXX±0.15	.xxx.*±0.5°						
SHEET	1/1						